



Section 7 Wooden Door Locks



- Technical Features**
- ☛ Robust construction for high level durability....
.....and security
 - ☛ Black powder coated steel case gives.....
.....exceptional corrosion resistance
 - ☛ Single throw brass deadbolt with hardened steel..
.....rotating pins to prevent sawing.
 - ☛ **Brass Latch, Pull and Twist for on site handing**
 - ☛ 35° follower action for firm positive opening action,
....with firm follower spring for heavy duty handles.
 - ☛ Suitable for Large Oval cylinders as well
 - ☛ Separate forend in stainless steel or brass,
.....to conceal all fixings.

- Included**
- Flat strike, stainless steel or brass.
 - Fixing screws for lock and striker

Specification

- **Bolt Tested:**
 - 500 kg side push resistant
 - 400 kg front push resistant
- **Durability Tested:**
 - 200 000 cycles 120N load ..
.. on the latch
- **Door Suitability**
 - up to 200kg doors, 15N max
...closing force.
- **Corrosion Resistance: F**
 - High Corrosion Resistant
 - 96 hour salt spray test



Item	Description	Faceplate	Throws	Type	Backset	Finish	Price without Cylinder
<ul style="list-style-type: none"> ☛ Dead lock version - Brass face plate and brass plated strike - Stainless Steel face plate and strike 		25	1	55210	57	00	
		25	1	55210	57	20	
<ul style="list-style-type: none"> ☛ Latch and dead bolt • Brass Latch, Pull and Twist for on site handing - Brass face plate and brass plated strike - Stainless Steel face plate and strike 		25	1	55220	57	00	
		25	1	55220	57	20	
<ul style="list-style-type: none"> ☛ Brass Rebate Kit for 55210, 55220 • Satin Brass • Satin Nickel Plated 				552RB 552RB		00 12	

LATCH LOCK ONLY

- ☛ **Brass Latch only**
- Face plate and strike Nickel Plated

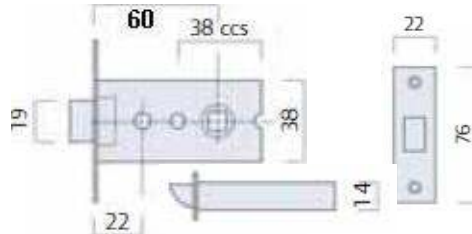



22



L3709	60	12
--------------	-----------	-----------

Legge





Item	Description	Faceplate	Throws	Type	Backset	Finish	Price without Cylinder
 	<p>Latch only- night latch version</p> <ul style="list-style-type: none"> • Anti-thrust dead locking latch • Hold open catch keeps latch withdrawn • Recommended: Half handle set inside, or with outside... ..handle fixed. 	25		55250	57	00	
	<ul style="list-style-type: none"> - Brass face plate and brass plated strike - Stainless Steel face plate and grey painted strike 	25		55250	57	20	

SASH LOCKS – 5 LEVER "500 KEY DIFFERS"

Item	Description	Faceplate	Throws	Type	Backset	Finish	Price
 	<p>Technical Features</p> <ul style="list-style-type: none"> • Yellow powder coated steel case • 5 brass close gate levers with anti-pick device. • Brass Latch, Pull and Twist for on site handing • Brass deadbolt with 2 hardened steel anti-saw inserts. • 2 Plated keys unnumbered 	25	1	52765	57	00	
	<ul style="list-style-type: none"> - Brass face plate and brass plated strike - Stainless Steel face plate and strike 	25	1	52765	57	20	
	<ul style="list-style-type: none"> - Stainless Steel face plate and strike- keyed alike 	25	1	52765K	57	20	
	<p>Included</p> <ul style="list-style-type: none"> • Box strike, Satin S/S or Polished Brass. • Fixing screws for lock and striker. 			Key blank 02765	00	00	

SASH LOCKS – 3 LEVER – HEAVY DUTY "100 KEY DIFFERS"

Item	Description	Faceplate	Throws	Type	Backset	Finish	Price
 	<p>Technical Features</p> <ul style="list-style-type: none"> • White powder coated steel case • 3 brass close gate levers with anti-pick device. • Brass Latch, Pull and Twist for on site handing • Brass deadbolt • 2 Plated keys unnumbered 	25	1	52763	57	00	
	<ul style="list-style-type: none"> - Brass face plate and brass plated strike - Stainless Steel face plate and strike 	25	1	52763	57	20	
	<ul style="list-style-type: none"> - Stainless Steel face plate and strike- keyed alike 	25	1	52763K	57	20	
	<p>Included</p> <ul style="list-style-type: none"> • Flat strike, Satin S/S or Polished Brass. • Fixing screws for lock and striker. 			Key blank 02765	00	00	



Technical Features

- Black painted steel case and cover
- Removeable brass faceplate and brass striker
- **Reversible** brass latch without opening lock.
- Brass double throw deadbolt

Operation

- From outside or inside: the latch is operated ...by key or handle. Deadbolt by key only

Finishes

- Satin Nickel plated – finish code "12"
- Satin Brass – finish code "00"



Included

- Strike
- Fixing screws for lock and striker

Certification

- ☞ This lock is certified according to EN 12209:03
- **Security grade 3:** Bolt
 - 500 kg side push resistant
 - 400 kg front push resistant
- **Durability grade X**
 - 200 000 cycles 120N load ..
 - .. on the latch
- **Corrosion Resistance: C**
 - High Corrosion Resistant
- **Door Mass grade 7**
 - up to 100kg doors, max 15N ..max. closing force.



Item	Description	Faceplate	Throws	Type	Backset	Finish	Price including Cylinder	Price without Cylinder	
LATCHING VERSION									
 	<p>Latch Version</p> <ul style="list-style-type: none"> • Double throw deadbolt and latch. • Cylinder 0G300-07 • Strike 06102-13 			Satin Brass Finish					
		22	2	5C110	40	00			
		22	2	5C110	50	00			
		22	2	5C110	60	00			
	22	2	5C110	70	00				
					Satin Nickel Plated Finish				
	22	2	5C110	40	12				
	22	2	5C110	50	12				
	22	2	5C110	60	12				
	22	2	5C110	70	12				
					521RB	00			
					521RN	12			
ROLLER BOLT VERSION									
	<p>Rollerbolt Version</p> <ul style="list-style-type: none"> • Double throw deadbolt and roller. • Cylinder 0G300-07 • Strike 06149.00. • Include rose set 06012 			Satin Brass Finish					
		22	2	5C120	40	00			
		22	2	5C120	50	00			
		22	2	5C120	60	00			
	22	2	5C120	70	00				
					Satin Nickel Plated Finish				
	22	2	5C120	40	12				
	22	2	5C120	50	12				
	22	2	5C120	60	12				
	22	2	5C120	70	12				



Technical Features

- Galvanised steel case and cover
- Removeable steel faceplate and steel striker
- **Reversible BICONICAL latch**
- Non handed – change latch without opening lock
- Brass or nickel plated steel double throw deadbolt
- ☞ *Round faceplate and strike upon request*

☞ **Operation**

- From outside or inside: the latch is operated ...by key or handle. Deadbolt by key only

☞ **Finishes**

- Nickel plated – finish code "12"
- Brass plated – finish code "00"



☞ **Included**

- Strike
- Fixing screws for lock and striker

Certification

- ☞ This lock is certified according to EN 12209:03
- **Security grade 3: Bolt**
 - 500 kg side push resistant
 - 400 kg front push resistant
- **Durability grade X**
 - 200 000 cycles 120N load ..
 - .. on the latch
- **Corrosion Resistance: C**
 - High Corrosion Resistant
- **Door Mass grade 7**
 - up to 100kg doors, max 15N ..max. closing force.



Item	Description	Faceplate	Throws	Type	Backset	Finish	Price including Cylinder	Price without Cylinder	
LATCHING VERSION		Brass Plated Finish							
 <p>Latch Version</p> <ul style="list-style-type: none"> • Double throw deadbolt and latch. • Cylinder 08010-07 • Strike 06102-13 <p>Latch Version for WC Indicator</p> <ul style="list-style-type: none"> • Single throw deadbolt and latch. • Use with WC Indicator:- 8mm spindle • Strike 06102-13 <p>Rebate Kit</p> <ul style="list-style-type: none"> • Steel satin brass plated • Satin stainless steel finish "20" 		22	2	5C611	40	00			
		22	2	5C611	50	00			
		22	2	5C611	60	00			
		22	2	5C611	70	00			
	Nickel Plated Finish								
		22	2	5C611	40	12			
		22	2	5C611	50	12			
		22	2	5C611	60	12			
		22	2	5C611	70	12			
	Brass Plated Finish								
		22	1	5C651	50	00			
		22	1	5C651	60	00			
Nickel Plated Finish									
	22	1	5C651	50	12				
	22	1	5C651	60	12				
				521BP		00			
				521SS		20			
ROLLER BOLT VERSION		Brass Plated Finish							
 <p>Rollerbolt Version</p> <ul style="list-style-type: none"> • Double throw deadbolt and roller. • Cylinder 08010-07 • Strike 06149.00. • Include rose set 06012 		22	2	5C621	40	00			
		22	2	5C621	50	00			
		22	2	5C621	60	00			
		22	2	5C621	70	00			
	Nickel Plated Finish								
		22	2	5C621	40	12			
		22	2	5C621	50	12			
		22	2	5C621	60	12			
	22	2	5C621	70	12				

Technical features:

- "U" Shaped adjustable faceplate
22 x10mm in satin finished laquered brass,
2600mm long.
- Upper adjustment 650mm
- lower adjustment 35mm.
- Zinc plated steel case.
- Reversible nickel plated latch
- Nickel plated DOUBLE THROW deadbolt.

Supplied as standard:

- Striker and fixing screws
- Without cylinder.
- Instruction sheet

Hand:

0 = Non-handed



Description		Code	Backset	Finish	Price w/out Cylinder
<p>Channel 2600 x 22 x10mm</p> 					
53131	<p>53131 -Top & Bottom - Locking features</p> <ul style="list-style-type: none"> • Latch-bolt and central dead-bolt. • Top and bottom extended bolts... ..integrally mounted on the face plate <p>Including :</p> <ul style="list-style-type: none"> • Central striker 06213-05 • 2 upper strikers 06292-00 and 06292-01 • Floor striker 06086-00 • Supplied without cylinder 	<p>Satin Brass Finish</p> <p>53131 45 00 53131 50 00 53131 60 00</p> <p>Nickel Plated Finish</p> <p>53131 45 12 53131 50 12 53131 60 12</p>			
53135	<p>53135 -Side locking - Locking features</p> <ul style="list-style-type: none"> • Latch-bolt and central dead-bolt. • Top and bottom front dead-bolts operated.. ..by rods integrally mounted on the faceplate <p>Including :</p> <ul style="list-style-type: none"> • Central striker 06213-05 • 2 lateral strikers 06323-01 • Supplied without cylinder 	<p>Satin Brass Finish</p> <p>53135 45 00 53135 50 00 53135 60 00</p> <p>Nickel Plated Finish</p> <p>53135 45 12 53135 50 12 53135 60 12</p>			
	<p>53137 -5 Locking points - Locking features</p> <ul style="list-style-type: none"> • Latch-bolt and central dead-bolt. • Top and bottom front dead-bolts operated.. ..by rods integrally mounted on the faceplate • Top and bottom extended bolts... ..integrally mounted on the face plate <p>Including :</p> <ul style="list-style-type: none"> • Central striker 06213-05 • 2 lateral strikers 06323-01 • 2 upper strikers 06292-00 and 06292-01 • Floor striker 06086-00 • Supplied without cylinder 	<p>Satin Brass Finish</p> <p>53137 45 00 53137 50 00 53137 60 00</p> <p>Nickel Plated Finish</p> <p>53137 45 12 53137 50 12 53137 60 12</p>			
	<p>53137 5 LOCKING POINTS</p>				
<p>ROLLER BOLT VERSIONS</p> <p>All Above are availbale in Roller Bolt Versions. Specify "R" prefix , and state "Roller" on the Order No Surcharge for this version.</p>					
<p>Lead time: Nickel plated finish is made on demand and lead time is two weeks.</p>					

NEW

NEW



Technical features:

- Black painted steel case and cover.
- Brass faceplate and strike
- Double throw deadbolt made of brass.

Available finishes:

- Satin nickel plated brass (fin.12)
- Satin brass (fin.00)

Supplied as standard:

- Striker
- Fixing screws for lock and striker
- Cylinder fixing screw
- Rose set

Conforms to EN 12209:2003

- Complies with Durability Grade C - 50 000 test cycles.
- Complies with Door Mass Grade 7 - up to 100 kg door mass: 15N max closing force.

Type	Description	Throws	Code	Backset	Finish	Price including Cylinder	Price without Cylinder	
<p>Single throw deadbolt</p> <ul style="list-style-type: none"> • Strike 07032 • Cylinder 0G545-05 • Rose set 06012.00 		1	52210	25	00			
		1	52210	25	12			
	<p>Double throw deadbolt</p> <ul style="list-style-type: none"> • Strike 07032 • Cylinder 0G545-05 • Rose set 06012.00 • Satin brass faceplate and strike finish 00. • Satin nickel plated finish 12. <p>Brass Rebate Kit</p> <ul style="list-style-type: none"> • Satin Brass • Nickel plated finish 12. <p>☞ Metal Weld-on Box for Metal Gates</p>		2	52310	40	00		
		2	52310	40	12			
		2	52310	50	00			
		2	52310	50	12			
		2	52310	60	00			
		2	52310	60	12			
		2	52310	70	00			
		2	52310	70	12			
				523RB		00		
				523RN		12		
			523M	60				

CYLINDER HOOK LOCKS – BRASS AND STEEL VERSIONS



Technical features:

- Zinc plated steel case and cover.
- Brass faceplate and strike (series 45100).
- Steel faceplate and strike (series 45110).
- Passivated laminated steel hook.

Supplied as standard:

- Striker, Rose set with screws.
- Fixing screws for lock and striker
- Cylinder fixing screw

Available finishes:

- Series 45100**
- Satin nickel plated brass (fin.12)
 - Satin brass (fin.00)
- Series 45110**
- Brass plated (fin.00)
 - Nickel plated (fin.12)

45110 Conforms to EN 12209:2003

- Complies with Durability Grade C - 50 000 test cycles.
- Complies with Door Mass Grade 8 - up to 200 kg door mass: 15N max closing force.

Type	Description	Code	Backset	Finish	Price including Cylinder	Price without Cylinder
<p>Brass faceplate and striker</p> <ul style="list-style-type: none"> • Strike 07028.10 • Cylinder 0G545-05 • Rose set 06012.00 • Satin brass faceplate and strike finish "00". • Satin nickel plated finish "12". <p>Steel faceplate and striker</p> <ul style="list-style-type: none"> • Strike 07028 • Cylinder 0G545-05 • Rose set 06012.00 • Brass plated faceplate and strike finish "00". • Satin nickel plated finish "12". <p>☞ Version with Steel Guide pin</p>		45100	35	00		
		45100	35	12		
		45100	40	00		
		45100	40	12		
		45100	50	00		
		45100	50	12		
		45100	60	00		
		45100	60	12		
		45110	40	00		
		45110	40	12		
		45110	50	00		
		45110	50	12		
		45110	60	00		
		45110	60	12		
		45112	60	12		



Technical features:

- Steel faceplate and strike.
- Zinc plated steel case
- Flat reversible nickel plated latch.
- Three DOUBLE throw nickel plated steel bolts.

Operation:

- From outside or inside: the latch is operated by key or handle; the deadbolts are operated by key only.

Supplied as standard:

- Striker
- Fixing screws for lock and striker
- Cylinder fixing screw.

Available finishes:

- Laquered satin brass plated.

Hand:

0 = Non-handed

Type	Description	Throws	Code	Backset	Finish	Price including Cylinder	Price without Cylinder	
	<p>Latch and multiple bolts</p> <ul style="list-style-type: none"> • Strike 06278-11 • Cylinder 0E300-10 							
		Brass plated	2	52521	60	00		
		Nickel plated	2	52521	60	12		

SECURITY LOCKS WITH DOUBLE BITTED KEY – 4 THROW DEADBOLT



Technical features:

- Nickel Plated satin steel faceplate and striker.
- Zinc plated steel case.
- Reversible nickel plated latch.
- Nickel plated steel deadbolt.

Operation:





- From outside or inside: the latch is operated by key or handle; the deadbolt is operated by key only.

Supplied as standard:

- Striker
- Fixing screws for lock and striker
- 2 escutcheons: inside item 06143, outside item 06082
- 3 Keys

Hand:

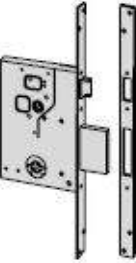
0 = Non-handed

Type	Description	Key Item	Throws	Code	Backset	Finish	Price
	<p>Deadbolt only</p> <ul style="list-style-type: none"> • Strike 06213 	 00100.D0.1	4	57010	50		
		 00101.D0.1	4	57014	50		
	<p>Latch and deadbolt</p> <ul style="list-style-type: none"> • Strike 06271 	 00100.D0.1	4	57250	60		

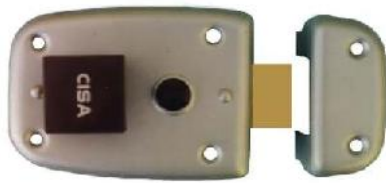

Technical features:

- Steel case and striker painted GREY (finish 97).
- Brass latch and deadbolt.
- PVC Knobs.
- Three DOUBLE throw nickel plated steel bolts.

Supplied as standard:







- Striker
- Fixing screws for lock and striker
- Instruction sheet.

Hand:

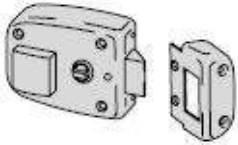

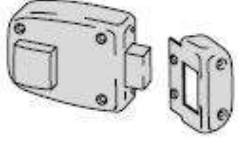
0 = Non-handed

Available finishes:

- Painted GREY (finish 97) only.

Type	Description	Cylinder	Code	Backset	Finish	Price
	<p>Night Latch.</p> <ul style="list-style-type: none"> • Cylinder 0G500 • Grey colour only (finish 97) • Inside knob • Dead locking latch with hold-open device. 		54315	60	97	
	<p>Deadbolt only</p> <ul style="list-style-type: none"> • Cylinder 0G500 • Grey colour only (finish 97) • Inside knob 		54340	60	97	
	<p>Jimmy proof lock</p> <ul style="list-style-type: none"> • Cylinder 0G2500 • Grey colour only (finish 97) • Inside knob with inside cylinder • Steel case 3mm thick. 					
	Latching version		48121	60	97	
	Deadbolt version		48221	60	97	

SECURITY RIM LOCKS WITH MULTIPLE DEADBOLTS - DOUBLE BITTED KEY

Type	Description	Key	Code	Backset	HAND	Price
	<p>Four throw deadbolt and latch</p> <ul style="list-style-type: none"> • Six levers • Anti drill protection • Five locking points • Includes extension bolts • Subsidiary driving mechanism 57190. • Includes escutcheons • Blank key ref 00125 		57175 57175	60 60	1 2	



Technical features:

- Laquered polished brass removable faceplate and striker.
- Zinc plated steel case.
- Reversible nickel plated silent action deadlocking latch.
- Nickel plated cut resistant deadbolt, with 25mm protrusion.
- Anti corrosion galvanised internal components.

Available finishes:

- On Request: Satin Stainless steel faceplate and strike (finish 20).

Supplied as standard:

- Striker and fixing screws
- Without cylinder.
- Instruction sheet



Standards:

- Locks with stainless steel faceplate and strike (finish 20) are certified fire-resistant by the American Underwriters Laboratory (UL Listed R14945(N)).

Hand:

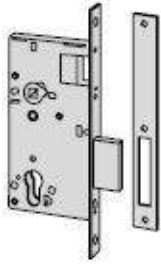

0 = Non-handed

Type	Description	Code	Backset	Finish	Price
	<ul style="list-style-type: none"> • Silent action deadlocking latch bolt only • Supplied with strike 06158-20, without cylinder. • Suitable for use with panic devices 59711 and 59607 <p>For Panic Function external doors.</p> <ul style="list-style-type: none"> • Operation: <ul style="list-style-type: none"> - The latch bolt is operated by handles or cylinderfrom both sides. - The outside handle must be fixed. <p>Classroom door lock with panic function.</p> <ul style="list-style-type: none"> • Operation: <ul style="list-style-type: none"> - The latch bolt is operated by handlefrom both sides. - The outside handle can be activated andde-activated by cylinder. • Uses split spindle 07206 	<p>52755</p> <p>52755</p>	<p>60</p> <p>60</p>	<p>00</p> <p>20</p>	
	<ul style="list-style-type: none"> • Silent action deadlocking latch and 25mm deadbolt. • Supplied with strike 06106-20, without cylinder. • Suitable for use with panic devices 59711 and 59607 <p>Entrance doors- Not Panic Function</p> <ul style="list-style-type: none"> • Operation: <ul style="list-style-type: none"> - The latch bolt is operated by handle or cylinderfrom either side. - The deadbolt is operated by cylinder from either side. <p>Panic Function doors with Automatic deadbolt.</p> <ul style="list-style-type: none"> • Operation: <ul style="list-style-type: none"> - Deadbolt automatically locks when door is closed. - The latch bolt is operated by handle or cylinderfrom either side. - The handle withdraws the latch and deadboltsimultaneously. - The outside handle must be fixed. <p>Hotel Lock with panic function</p> <ul style="list-style-type: none"> • Operation: <ul style="list-style-type: none"> - The latch bolt is operated by handle or cylinderfrom either side. - The handle withdraws the latch and deadboltsimultaneously. - The outside handle must be fixed. • Optional: Cylinder 08453 and Indicator of occupancy. <p>Classroom door lock with panic function.</p> <ul style="list-style-type: none"> • Operation: <ul style="list-style-type: none"> - The latch bolt is operated by handle from either side. - The deadbolt is operated by cylinder from either side. - The inside handle withdraws the latch and deadboltsimultaneously. With reversible panic function. • Uses split spindle 07206 	<p>52710</p> <p>52840</p> <p>52842</p> <p>52844</p>	<p>60</p> <p>60</p> <p>60</p> <p>60</p>	<p>20</p>	

Type	Description	Code	Backset	Finish	Price
	<ul style="list-style-type: none"> • Supplied with strike 06159-20, without cylinder. • Suitable for use with panic devices 59711 and 59607 Deadbolt only with panic function • Operation: <ul style="list-style-type: none"> - The deadbolt is operated by handle or cylinder ...from either side. - The outside handle must be fixed. 	52871	60		
	<p>Optional</p> <ul style="list-style-type: none"> • Rebate Kit for 52755, 52840 etc • Indicator of occupancy for 52840 • Split follower for 52760, 52844 	528RB	00	00	
		06146	00		
		07206	01		

LEGGE ADJUSTABLE ROLLER LATCH

Legge

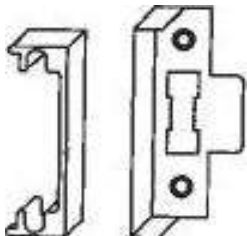
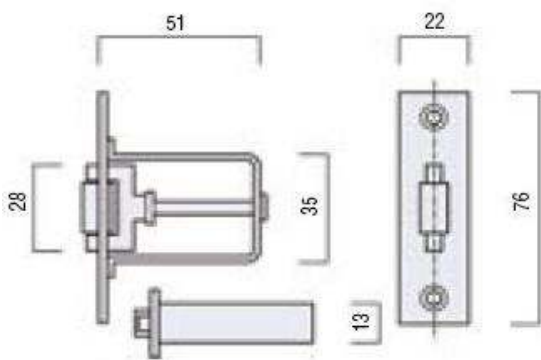
Type	Description	Code	Finish	Price
 	<p>☞ Adjustable Roller Latch</p> <ul style="list-style-type: none"> • Satin stainless steel face plate • Supplied with stainless steel strike • Brass roller, brass finish • Supplied with fixing screws 	IB1511	SS	
 	<p>☞ Rebate for Legge Roller Catch</p> <ul style="list-style-type: none"> • Steel chrome plated 	IB2566	CP	

